

Acova Artéa

Type CT, ACTI

et Acova Artéa Cristal

Type CMT, ACMT, TCMT

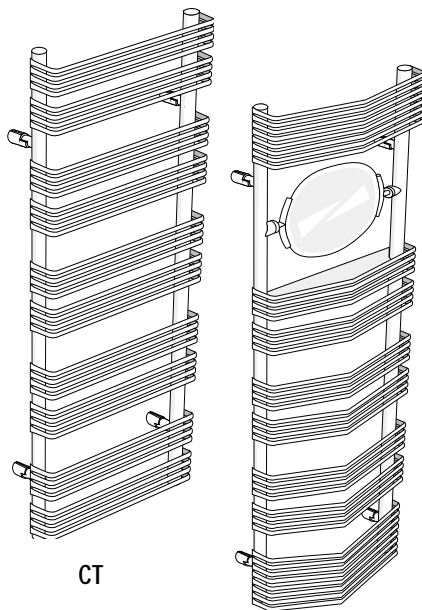

CT

CMT

ACIER

- Tubes émetteurs de Ø 12 mm. Épaisseur 1,25 mm.
- Collecteurs Ø 38 mm. Épaisseur 1,5 mm.
- Acier qualité 102 laminé à froid.
- Artéa Cristal : livré équipé du miroir pivotant et d'une tablette de rangement chromée.

PRESSIONS ET TEMPÉRATURE DE SERVICE

- De base : pression maximale de service 4 bar (400 kpa).
- Haute pression : pression maximale de service 10 bar (1000 kpa). \$
- Température maximale de service 110°C.

REVÊTEMENT

- Couche de protection appliquée par cataphorèse.
- Finition par revêtement poudre epoxy polyester.

COULEURS

- Teinte de base blanc 603 (RAL 9016).
- 50 teintes au choix. \$

FIXATIONS

- Sur consoles murales.

RACCORDEMENTS

- Bitube (voir page 61).
- Monotube (voir page 61). \$

RÉGULATION (TCMT, ACTI ET ACMT)

- Thermostat sans fil programmable CADIR (voir page 66).

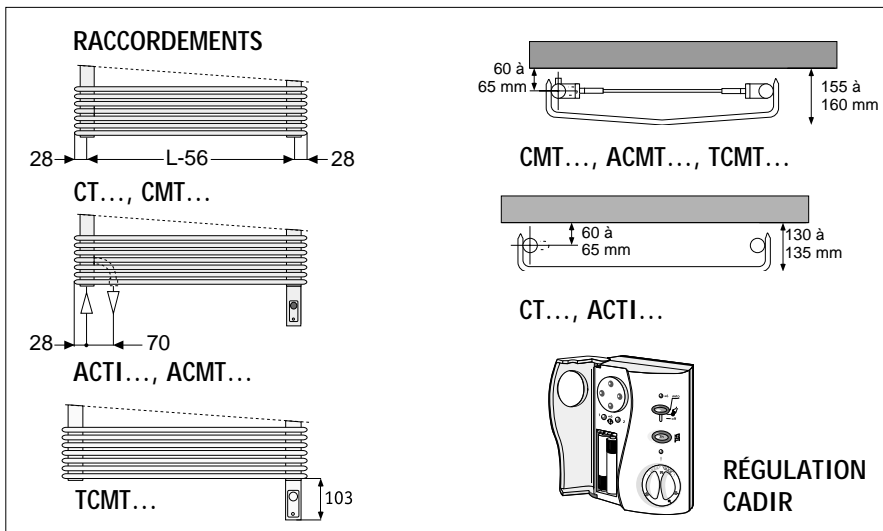

CT-204-066
ACTI-204-066

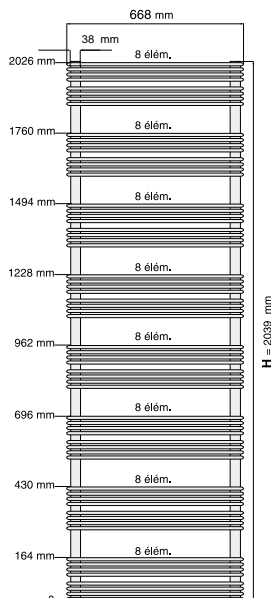

CT-151-046
ACTI-151-046

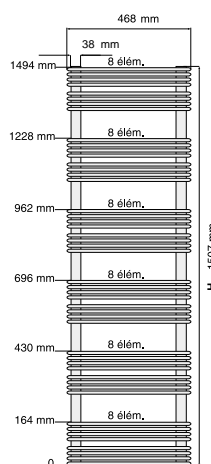

CT-124-046
ACTI-124-046

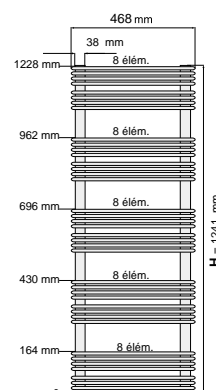

CT-069-116
ACTI-069-116

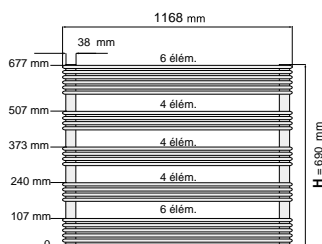

Références	Hauteur en cm	Pente	Puissance en W T. moyenne : 70°C Fluide 75/65		Puissance en W T. moyenne : 80°C Fluide 90/70		Poids en Kg	Capacité en dm ³
			ti 20°C Δt 50K	ti 22°C Δt 48K	ti 20°C Δt 60K	ti 22°C Δt 58K		
CT-069-116	69	1,153	892	851	1 101	1 058	13	3
CT-124-046	124,1	1,273	700	665	883	846	12	3
CT-151-046	150,7	1,265	846	803	1 065	1 021	15	3,5
CT-204-066	203,9	1,221	1 435	1 365	1 793	1 720	22	5,5
CMT-158-060	158,3	1,178	957	912	1 186	1 140	16	3,5

Mixte ACTI et ACMT

CLASSE II     IP 44 - IK09 

Références	Pente	Puissance en W T. moyenne : 70°C Fluide 75/65		Puissance en W T. moyenne : 80°C Fluide 90/70		Puissance électrique en W	Poids en Kg	Capacité en dm ³
		ti 20°C Δt 50K	ti 22°C Δt 48K	ti 20°C Δt 60K	ti 22°C Δt 58K			
ACTI-069-116	1,153	892	851	1 101	1 058	600	14	3
ACTI-124-046	1,273	700	665	883	846	600	13	3
ACTI-151-046	1,265	846	803	1 065	1 021	900	16	3,5
ACTI-204-066	1,221	1 435	1 365	1 793	1 720	1 500	23	5,5
ACMT-158-060	1,178	957	912	1 186	1 140	900	21,7	3,5

Électrique TCMT

CLASSE II       IP 44 - IK09 

Référence	Largeur en cm	Puissance en W	Poids en kg
TCMT-090-060	61,5	900	21,7

CMT-158-060
ACMT-158-060
TCMT-090-060

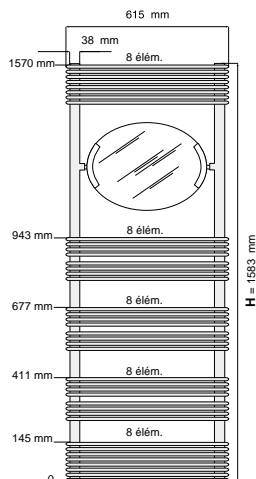

FIXATIONS

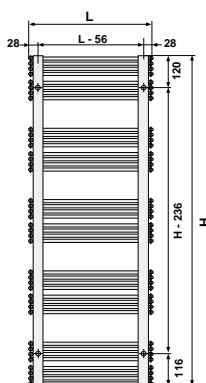

CONSOLE MURALE

